



KA Series

Closed linear grating scale

GUANGZHOU LOKSHUN CNC EQUIPMENT LTD.

Directory

General Description.....	-1
Operating Guideline.....	-2
Safety Considerations.....	-3
1. Technical Parameters.....	1
2. Encoder Structure.....	3
3. Optional Parts.....	4
4. Installation.....	7
4.1 Installation Dimension	7
4.2 Principle of installation.....	11
4.3 Installation of Encoder and Enclosure.....	12
4.4 Installation of Reading Head.....	15
4.5 Switchover of Reading Head Cable.....	17
5. Acceptance Rules.....	18

General Description

Many thanks for your use of this series of encoder. It is China's most famous international brand. It will be your best bet once you choose it. SINO brand was initially founded in 1989. We are a professional factory dedicated to manufacture of encoder numerical display. By continuous modification and improvement through years of research and production, we have developed today's KA series linear encoder. The KA series encoder under this manual includes KA-300, KA-600, KA-500 and KA-200, which can meet the requirements in different applications.

KA-300 is a type of encoder with wide applications. It features in optimal structure, good appearance and high rigidity, able to meet the needs of the majority of general machine users. The length is 70~1020mm.

KA-600 encoder, which is specifically designed for large machine tool, features in large size and good rigidity. Support may be added to any position of the encoder to enhance the rigidity and stability. The length is 1000~3000mm.

KA-500 is a mini-encoder specially designed for the machine tool which has a low installation size and small operation space. It can meet the needs of those customers who have requirements for position. The length is 70~470mm.

KA-200, a mini-encoder smaller than KA-500, is designed based on KA-500 by optimizing the internal and external structure. It is suitable to the equipment on which the installation is restricted and the space is even smaller. The length is 30-360mm.

Operating Guideline

- Before use, the user must read the General Description, Safety Considerations and all the contents in Chapter 1 ~ 3.
- Except the General Description, Safety Considerations and all the contents in Chapter 1 ~ 3, the technicians for installation, testing and repair must thoroughly understand all the contents in Chapter 4~5.
- This Operating Instructions is only applicable to SINO's KA series integrated linear encoder.
- Please read the Safety Considerations below. It is critical information related to safe use of your linear encoder.

Safety Considerations

Caution:

- To avoid electric shock or fire, the equipment connected to encoder shall be kept from moisture or direct contact with cooling liquids.
- Encoder is a precision measuring instrument. To ensure its normal function, never expose it to external shock or vibration.

Warning:

- To prevent mal-alignment of encoder and avoid electric shock, never open any seal on encoder. There is no part that needs the user's repair. Please ask the authorized technicians to repair.

Notes :

- If finding any smoke or smell from the reading head, please immediately cut off the power supply. As the encoder connects with the numerical display to form a precision measuring instrument, continued use in event of above phenomena might cause fire or electric shock to the numerical display. Please contact LOK SHUN CNC EQUIPMENT LTD. or its dealer. Never try to repair by yourself.
- Once the wire between numerical display and encoder is broken or damaged during use, it will cause error to the test data. The user shall take special care on this.
- Never try to repair or refit the scale, as it might cause failure, trouble or damage.



The displacement sensor complies with 2006/95/EC directive for low-voltage electric apparatus and 2004/108/EC directive for EMC.

Our company has passed the authorization and the audit of ISO9001 Quality System, ISO14001 Environmental System, OHSAS18001 Occupational Health and Safety System.

In light of the principle focused on easy installation, use and maintenance by the user, LOK SHUN CNC EQUIPMENT LTD. has developed KA series linear encoder based on the condition of optimized structure and guaranteed precision. With a precision conforming to standard, this product features in good rigidity, straightness, sealing and appearance. The accessories and spare parts are easy to install and repair, resulting in largely reduced installation labors. Please read the following chapters thoroughly, so that you may use this device more easily.

1. Technical Parameter

1.1 Scaling distance: 0.02 mm (50lines /mm)

1.2 Resolution: 5 μ m、 1 μ m、 0.5 μ m

1.3 Precision: $\pm 3\mu\text{m}$ 、 $\pm 5\mu\text{m}$ 、 $\pm 15\mu\text{m/m}$ (20 ± 0.1)

1.4 Measuring range: 30~3000mm

1.5 Moving speed: High-speed encoder 120 m/min (To be customized)

Ordinary encoder 60m/min

1.6 Power supply: +5V \pm 5%、 80mA

1.7 Cable length: Standard 3m (Special length available according to the user's needs)^①

1.8 Working Temperature: 0~45

1.9 Pin Description:

1) Applicable to: 9 pin socket RS-422 signal Output.

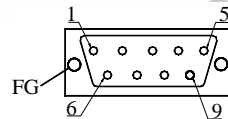

Pin Position	1	2	3	4	5	6	7	8	9
Signal	\bar{A}	OV	\bar{B}	Empty	\bar{Z}	A	+5V	B	Z
Color	Green Black	Black	Orange black	FG	White black	Green	Red	Orange	White

FG: Shield connected to metal casing.

^① Standard Cable Length for KA -200 Encoder:2m .

2) Applicable to: 9 pin socket TTL signal Output.

Pin Position	1	2	3	4	5	6	7	8	9
Signal	Empty	<i>OV</i>	Empty	Empty	Empty	<i>A</i>	+5V	<i>B</i>	<i>Z</i>
Color	-	Black	-	FG	-	Green	Red	Orange	White

FG: Shield connected to metal casing.

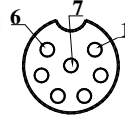

3) Applicable to: 7 pin socket TTL signal Output.

Pin Position	1	2	3	4	5	6	7
Signal	<i>OV</i>	Empty	<i>A</i>	<i>B</i>	+5V	<i>Z</i>	Shield
Color	Black	-	Green	Orange	Red	White	-

1.10 Signal Waveform

TTL signal Output:

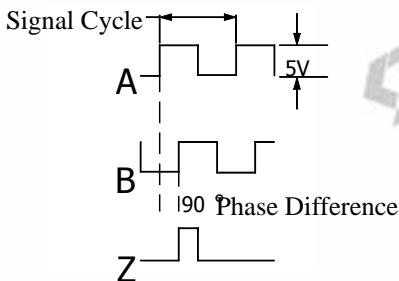

RS-422 signal Output:

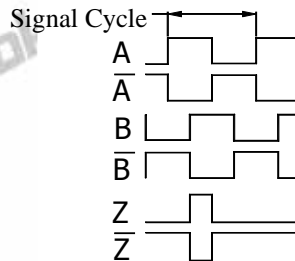

1.11 Encoder Zero Position: 1 every 50mm

1.12 Output pulse signal cycle of encoder PW

Resolution	Equivalent per pulse PW
5 μ m	20 μ m
1 μ m	4 μ m
0.5 μ m	2 μ m

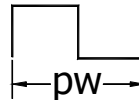

2. Encoder Structure:

The encoder mainly consists of scaling body and reading head, as shown in Fig.1:

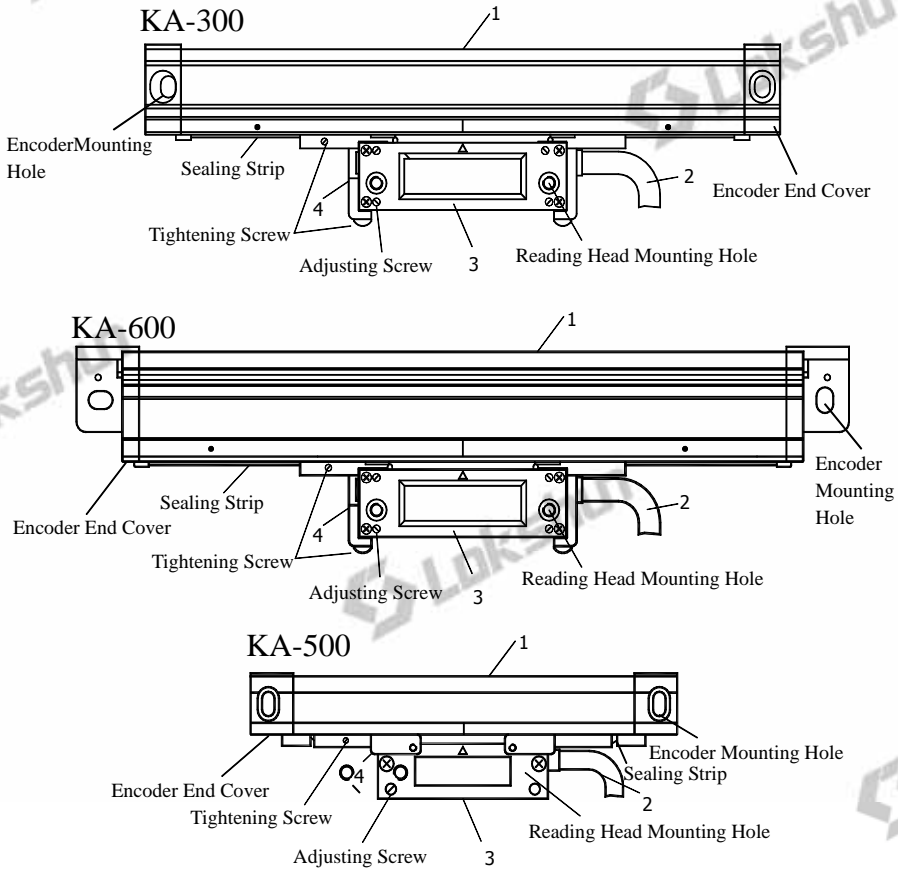

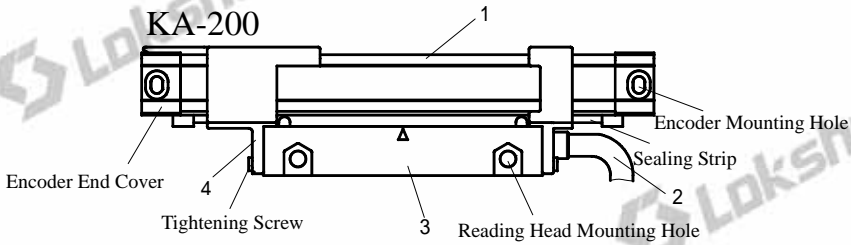

Fig. 1

1. Scaling body 2. Cable 3. Read head 4. Connection plate fixing the reading head

3. Optional Parts

To install and use the encoder normally under different conditions, we have designed the following spare parts:

KA-300:

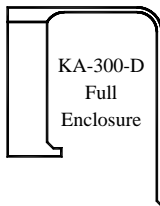

Fig. 2

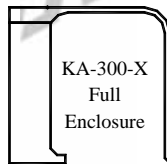

Fig. 3

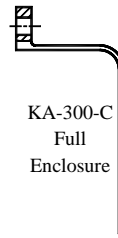

Fig. 4

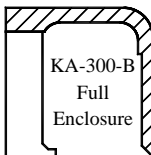
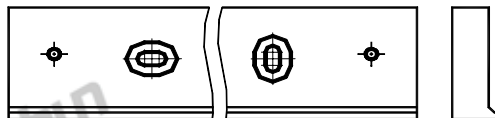

Fig. 5



KA-300 Supporting Plate

Fig. 6

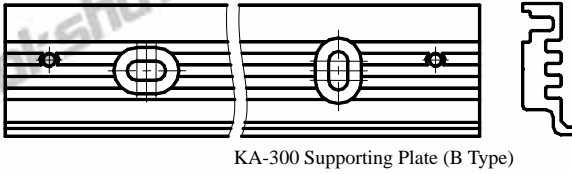

Fig. 7

KA-600:

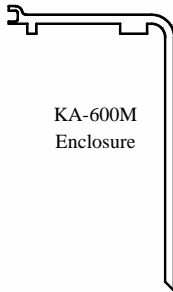

Fig. 8

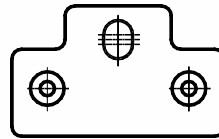

Fig. 9

KA-500:

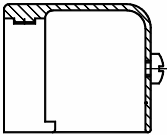

Fig.10

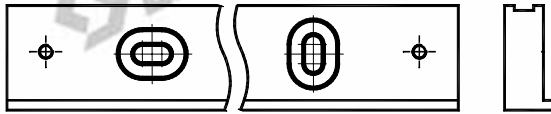

Fig. 11

KA-200:



Fig. 12

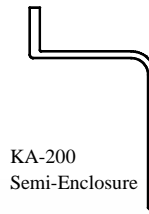
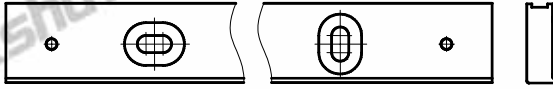

Fig. 13



KA-200 Supporting Plate

Fig. 14

General Parts for Installation: T-Type Frame A, B, C, D, E

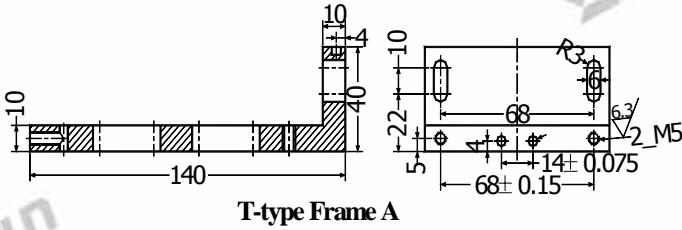

T-type Frame A

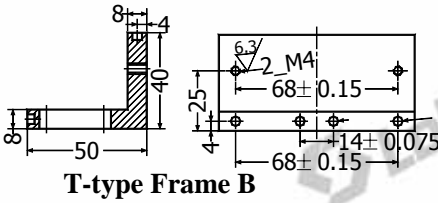

T-type Frame B

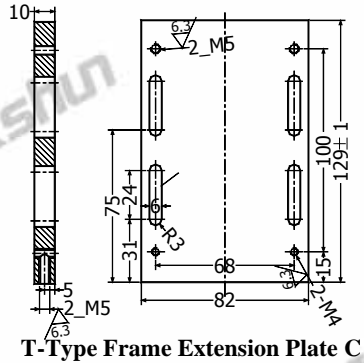

T-type Frame Extension Plate C

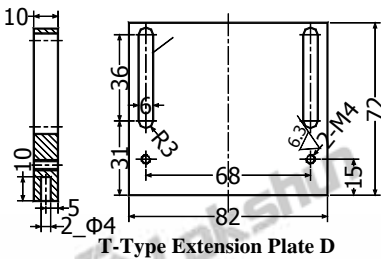

T-type Extension Plate D

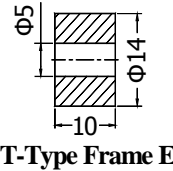

T-type Frame E

Fig. 15

4. Installation

4.1 Installation Dimension

Overall Dimension of KA-300 Encoder

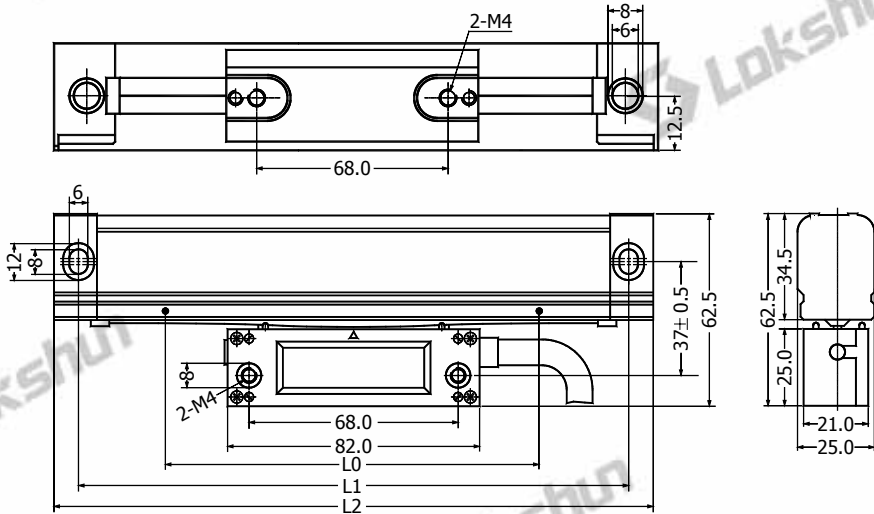

Fig.16

Model	L0	L1	L2	Model	L0	L1	L2
KA300-70	70	160	176	KA300-570	570	660	676
KA300-120	120	210	226	KA300-620	620	710	726
KA300-170	170	260	276	KA300-670	670	760	776
KA300-220	220	310	326	KA300-720	720	810	826
KA300-270	270	360	376	KA300-770	770	860	876
KA300-320	320	410	426	KA300-820	820	910	926
KA300-370	370	460	476	KA300-870	870	960	976
KA300-420	420	510	526	KA300-920	920	1010	1026
KA300-470	470	560	576	KA300-970	970	1060	1076
KA300-520	520	610	626	KA300-1020	1020	1110	1126

L0: Effective measuring length of encoder L1: Dimension of encoder mounting hole

L2: Encoder overall dimension

Overall Dimension of KA-600 Encoder

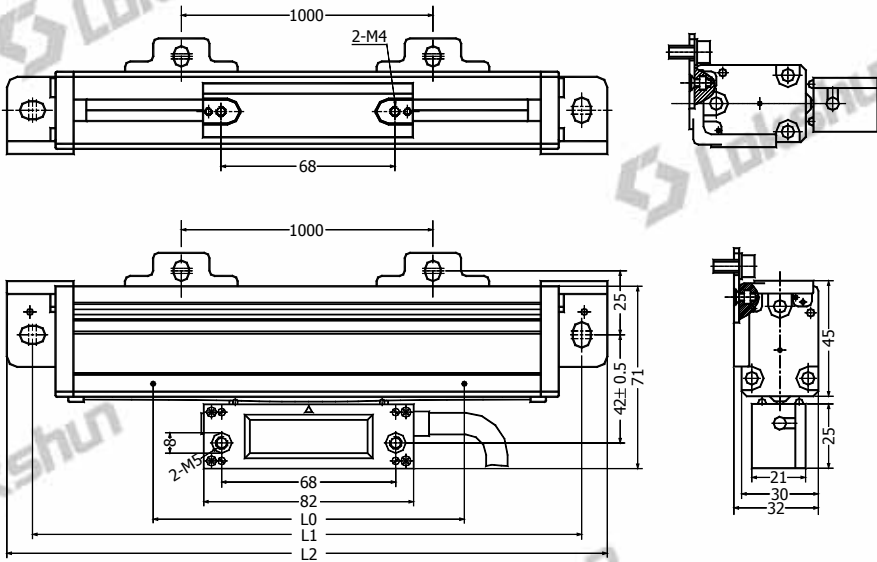

Fig.17

Model	L0	L1	L2	Model	L0	L1	L2
KA600-1000	1000	1150	1170	KA600-2100	2100	2250	2270
KA600-1100	1100	1250	1270	KA600-2200	2200	2350	2370
KA600-1200	1200	1350	1370	KA600-2300	2300	2450	2470
KA600-1300	1300	1450	1470	KA600-2400	2400	2550	2570
KA600-1400	1400	1550	1570	KA600-2500	2500	2650	2670
KA600-1500	1500	1650	1670	KA600-2600	2600	2750	2770
KA600-1600	1600	1750	1770	KA600-2700	2700	2850	2870
KA600-1700	1700	1850	1870	KA600-2800	2800	2950	2970
KA600-1800	1800	1950	1970	KA600-2900	2900	3050	3070
KA600-1900	1900	2050	2070	KA600-3000	3000	3150	3170
KA600-2000	2000	2150	2170				

L0: Effective measuring length of encoder L1: Dimension of encoder mounting hole

L2: Encoder overall dimension

Overall Dimension of KA-500 Encoder

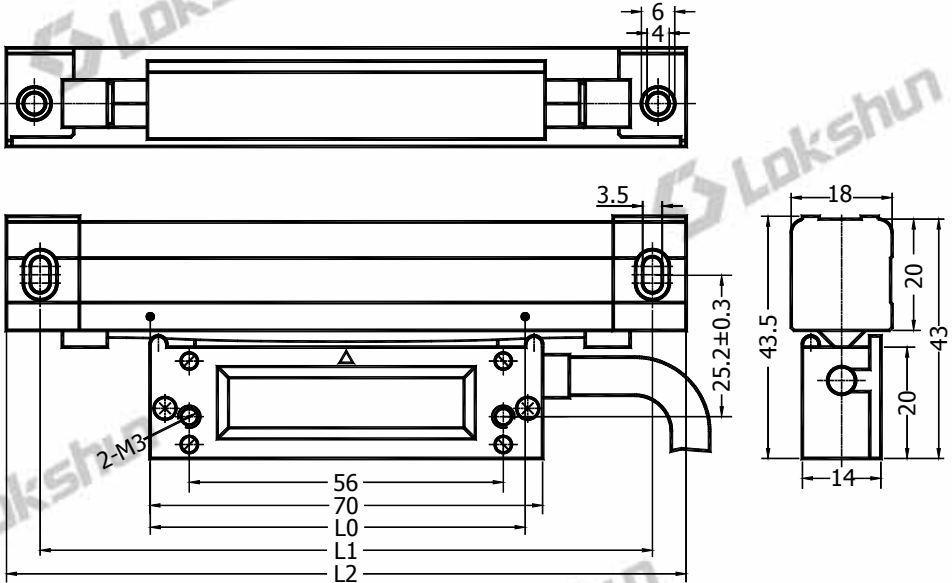

Fig.18

Model	L0	L1	L2	Model	L0	L1	L2
KA500-70	70	172	182	KA500-320	320	422	432
KA500-120	120	222	232	KA500-370	370	472	482
KA500-170	170	272	282	KA500-420	420	522	532
KA500-220	220	322	332	KA500-470	470	572	582
KA500-270	270	372	382				

L0: Effective measuring length of encoder

L1: Dimension of encoder mounting hole

L2: Encoder overall dimension

Overall Dimension of KA-200 Encoder

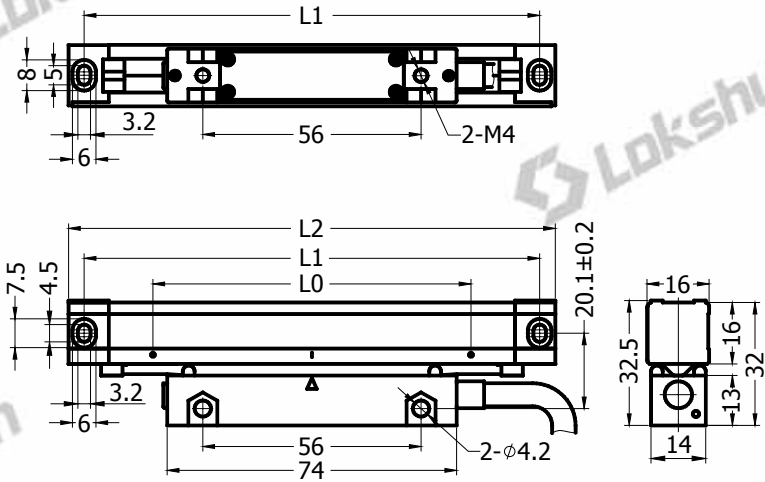

Fig.19

Model	L0	L1	L2	Model	L0	L1	L2
KA200-30	30	125	133	KA200-160	160	255	263
KA200-40	40	135	143	KA200-170	170	265	273
KA200-50	50	145	153	KA200-180	180	275	283
KA200-60	60	155	163	KA200-190	190	285	293
KA200-70	70	165	173	KA200-200	200	295	303
KA200-80	80	175	183	KA200-220	220	315	323
KA200-90	90	185	193	KA200-240	240	335	343
KA200-100	100	195	203	KA200-260	260	355	363
KA200-110	110	205	213	KA200-280	280	375	383
KA200-120	120	215	223	KA200-300	300	395	403
KA200-130	130	225	233	KA200-320	320	415	423
KA200-140	140	235	243	KA200-340	340	435	443
KA200-150	150	245	253	KA200-360	360	455	463

L0: Effective measuring length of encoder L1: Dimension of encoder mounting hole

L2: Encoder overall dimension

Note: (1) Select the measuring range of encoder according to the travel of machine tool. The measuring range of encoder must be higher than the maximum travel of

the machine tool.

(2) Select proper parts according to the length and mounting plane provided.

(3) The hanging plate needed for KA-600 encoder shall be arranged every 1000mm, respectively 2 hanging plates if $1000 < L < 2000$; 3 plates if $2000 < L < 3000$; and 4 plates if $L = 3000$.

4.2 Principle of Installation:

(1) The encoder must be installed with the guide rail of machine tool as the benchmark and be kept in parallel. The center of encoder measuring range must be positioned on the center of travel of machine tool. Ensure that the actual measuring range of encoder is higher than the maximum travel of machine tool.

(2) The installation shall be based on priority principle as such that the encoder shall be installed close to the drive screw of machine tool. After installation, the body of encoder moves with the work bench, while the reading head is fixed on the machine tool.

(3) The encoder shall be so installed that it will not obstacle the operation or reduce the function of machine tool.

(4) After installation, the encoder shall be kept from knock. During machining, it shall not obstacle the handle of machine tool or affect the brake or other protrusions. It is not easy to contact when a work piece drops.

(5) The encoder shall be vertically installed, as shown in Fig.20. But wherever impermissible, horizontal installation is also acceptable. Never install the encoder upside down (that is, reading head on top and encoder body at lower). Never direct the rubber seal of encoder toward the outlet of cooling oil from machine tool.

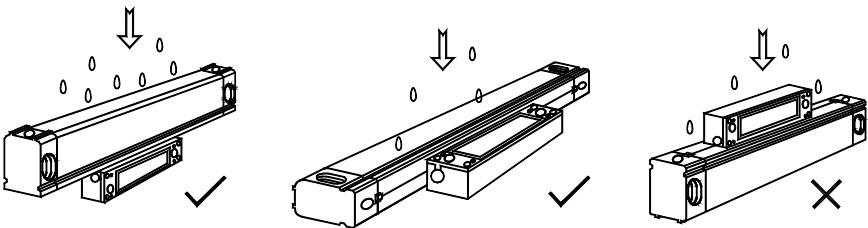

Fig 20

(6) The encoder enclosure shall be securely earthed to ensure the signal integrity.

(7) The parallelism and verticality between encoder and guide rail of machine tool shall be within 0.10 mm/m.

4.3 Installation of Encoder and its Enclosure

(1) Installation of KA-300C Enclosure Encoder

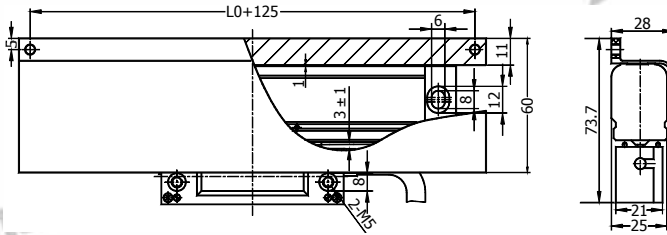

- a. Select proper installation position;
- b. Mark line on the mounting plane according to the length of installation, and drill M4 mounting hole.
- c. Install the encoder onto mounting plane. Use the dial gauge to check the parallelism between encoder and guide rail of machine tool, and adjust it to best state. (See Fig. 21)

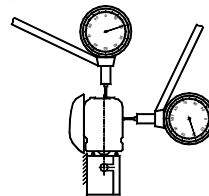
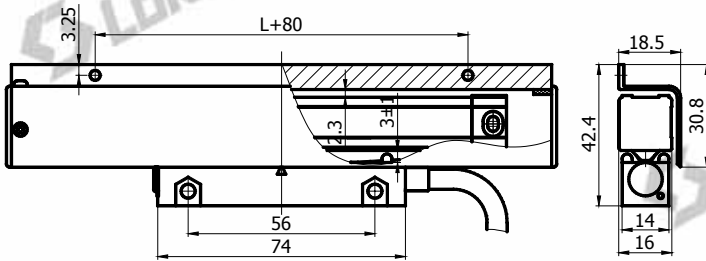

Fig .21

- d. Fix the encoder onto mounting plane.
- e. Adjust the screw fixing the reading head, making it slightly touch the mounting plane.
- f. Drill M4 screw hole according to the mounting hole on reading head.
- g. Fix the reading head and remove the connection plate.
- h. Drill M4 screw hole according to the mounting hole on encoder enclosure.
- i. Fix the encoder onto mounting plane.

(2) KA-200 Semi-enclosure Encoder:



The installation method is same as that for KA-300C enclosure encoder.

(3) KA-300B Enclosure Encoder

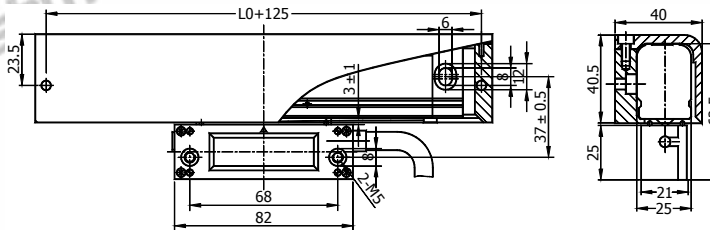

- a. Select proper installation position
- b. Mark line on the mounting plane according to the mounting dimension of reinforced support plate for B-type enclosure. Drill M4 screw hole.
- c. Fix the reinforced support plate slightly onto mounting plane. Use dial gauge to check the parallelism between reinforced support plate and guide rail of machine tool, and adjust it to best state. (Fig. 22)
- d. Fix the reinforced support plate onto mounting plane.
- e. Install the encoder onto reinforced support plate.
- f. Adjust the screw fixing the reading head, making it slightly touch the mounting plane.

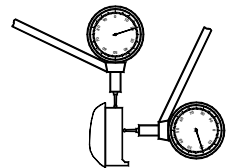
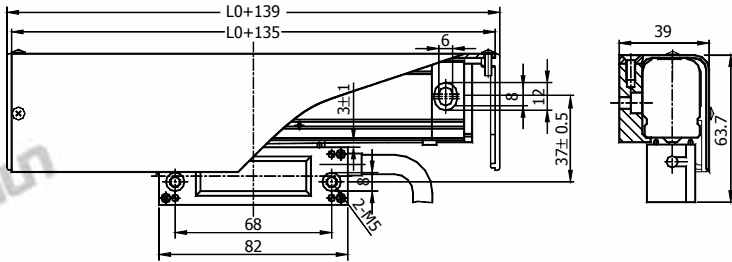

Fig .22

- g. Drill M4 screw hole according to the mounting hole on reading head.
- h. Fix the reading head and remove the connection plate.
- i. Fix the encoder onto reinforced support plate.

(4) Installation of D, X & H Enclosure and KA-200 Full-enclosure Encoder

KA-300D Enclosure Encoder:



KA-300X Enclosure Encoder:

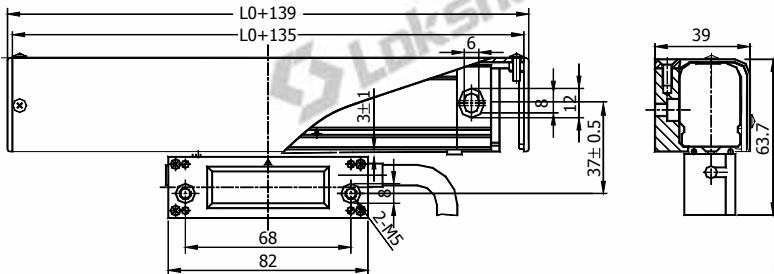

KA-500H Enclosure Encoder:

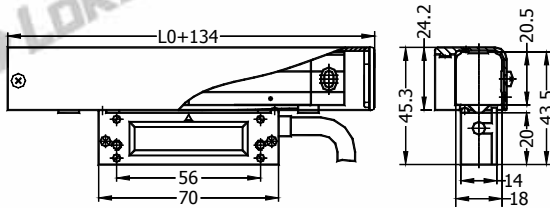

KA-200 Full-Enclosure Encoder:

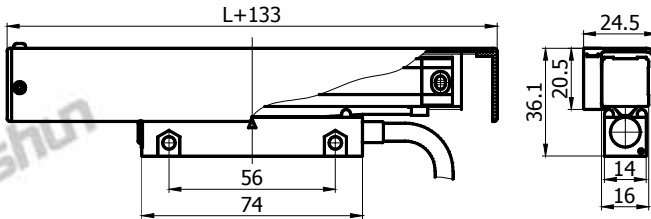

The installation method is same as that for KA-300B enclosure encoder.

(5) Installation of KA-600M Enclosure Encoder

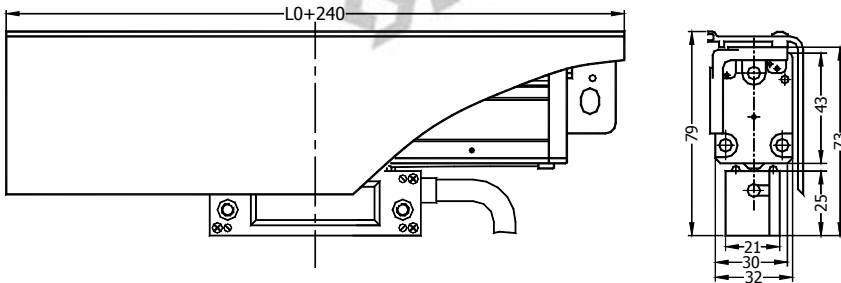

4.4 Installation of Reading Head

The reading head may be positively or reversely installed on the machined or non-machined plane. Generally, positive installation is used. The reverse installation is used only when the installation space is not enough and it is not easy to install positively.

(1) Positive Installation of Reading Head

Shown in Fig. 23 is positive installation of reading head. During installation, take care

that the encoder plane shall be kept parallel to the reading head plane and that their sectional centers shall be kept consistent, with an error within 0.10mm.

(2) Reverse Installation of Reading Head

Shown in Fig. 24 is reverse installation of reading head. The installation steps are as follows:

- a. Install T-frame (optional) onto machine tool.
- b. Remove the connection plate fixing the reading head.
- c. Adjust the tightening screw on T-frame mounting plate, making it slightly touch the reading head.
- d. Use front and rear M5 screw to fix the reading head onto mounting plate of T-frame.
- e. Adjust the position of T-frame plates, making the reading head in a relative position to the encoder as shown in Fig. 24.
- f. Install the encoder by using T-frame.

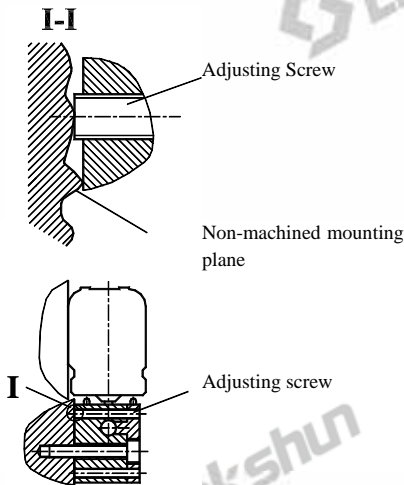

Fig. 23

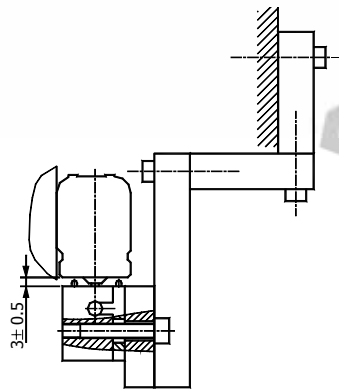
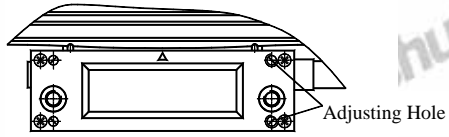

Fig. 24

4.5 Switchover of Reading Head Cable (Applicable to KA-300, KA-500 and KA-600)

Upon shipment, left or right outlet is available for the reading head cable according to different specifications. You may change the direction of the cable if needed. The steps are as follows:



- (1) Loosen and remove 4 cross-head screws M2 fixing the reading head cover and 2 adjusting screws M3 on the right side of reading head.
- (2) Put 2 socket hexagonal screws M4 into the adjusting screw hole and screw forward respectively to prop up the cover plate. When there is a clearance, use screwdriver to prize up the cover plate along the edge of reading head.
- (3) Loosen 2 slotted-head screws M3 fixing the cable on the bottom of reading head. Remove the cable and terminal. Change the direction.
- (4) Before reinstalling the cover plate, remove the original sealing glue before applying new sealing glue.
- (5) Remove socket hexagonal screw M4. Reinstall the cover plate and tighten 4 cross-head screws M2.

Note: To avoid slippery of screw head, please use correct tools in each step.

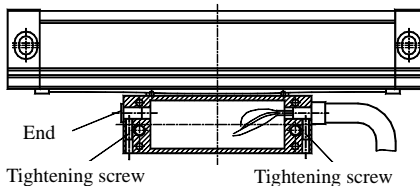

Note: The cable on KA-200 reading head is factory installed on right side. Installation on left side is available if requested.

5. Acceptance Rules

- 5.1 The connection of reading head shall have adequate rigidity. Shaking with force and observing the numerical display, the value shown on it will have some deviation. If releasing your hand, the value on numerical display shall be able to resume to original value.
- 5.2 The reading head shall located at the center of encoder, so that the sealing strip may close or open symmetrically, as shown.
- 5.3 The connecting plate may guarantee the position of reading head in encoder center and its relative position to encoder body.
- 5.4 The position of reading head relative to encoder and its mounting dimension are shown below.

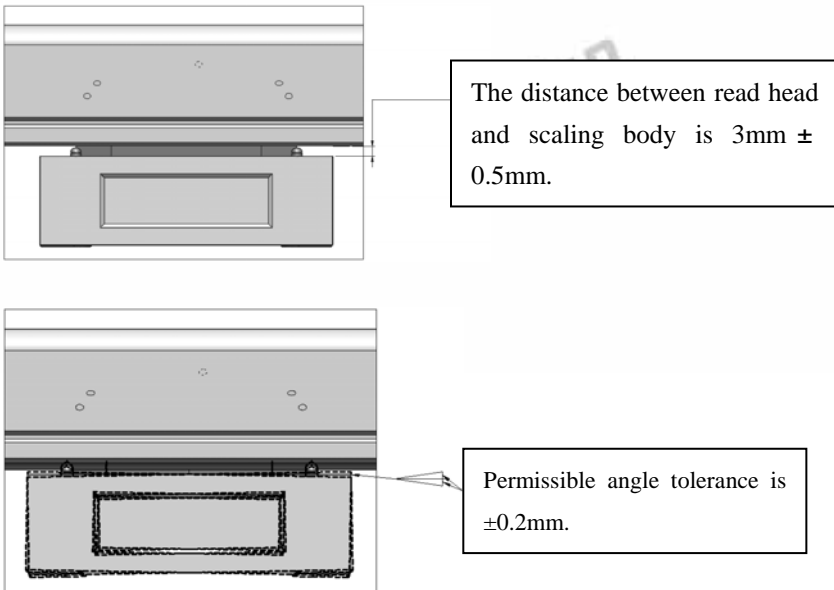

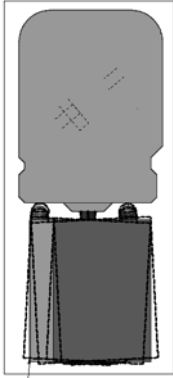

Permissible angle tolerance is $\pm 0.2\text{mm}$.

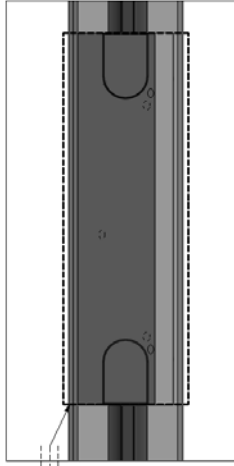

Permissible horizontal offset is $\pm 0.2\text{mm}$.

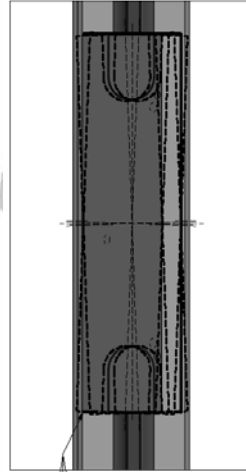

Permissible angle tolerance is $\pm 0.2\text{mm}$.

